

Republic

STORAGE SYSTEMS, LLC

and **THAT** makes
the difference!

service - integrity - excellence - quality - dependability

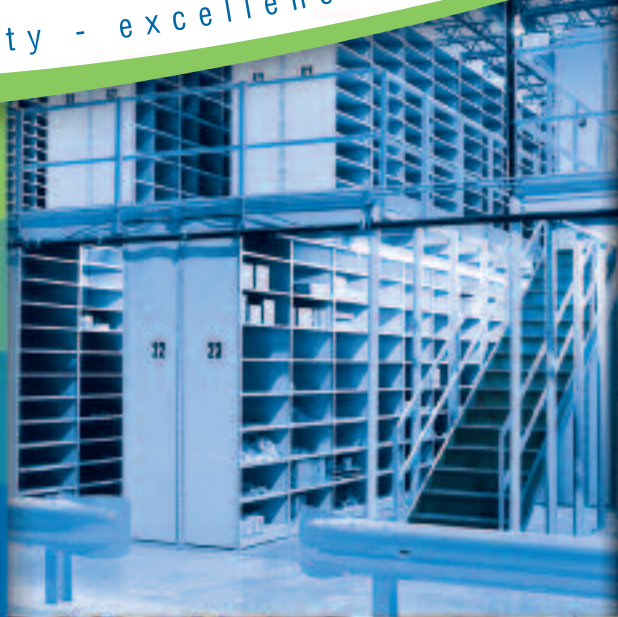

Storage **Solutions** Catalog

www.republicstorage.com

Original Wedge-Lock

Components

Wedge-Lock Shelf Framing Systems provide economical and versatile storage solutions for a variety of applications including retail stock rooms, auto parts centers and archive storerooms. The shelving units consist of primary framing members that snap together for easy assembly without bolts, clips or other fasteners.

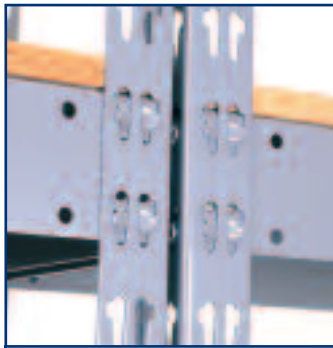

Original Connection

Shelves are accessible from all four sides because no cross-bracing is required. The Original Wedge-Lock design consists of two wedging lugs on the beam that engage tapered slots on the post for a strong, rigid connection.



Angle Post Heavy Duty Angle Post T-Post Heavy Duty T-Post

■ Angle Post

- 14 gauge angle formation
- two columns of slots for 2" vertical shelf adjustment
- used at aisle ends on standard and bulk units
- heights to 12'

■ Heavy Duty Angle Post

- 14 gauge angle formation
- two columns of slots for 2" vertical shelf adjustment
- used at aisle ends on high-capacity bulk units
- heights to 16'

■ T-Post

- 14 gauge T-formation
- four columns of slots for 2" vertical shelf adjustment
- used at intermediate positions on standard and bulk units
- heights to 12'

■ Heavy Duty T-Post

- 14 gauge T-formation
- four columns of slots for 2" vertical shelf adjustment
- used at intermediate positions on high-capacity bulk units
- heights to 16'

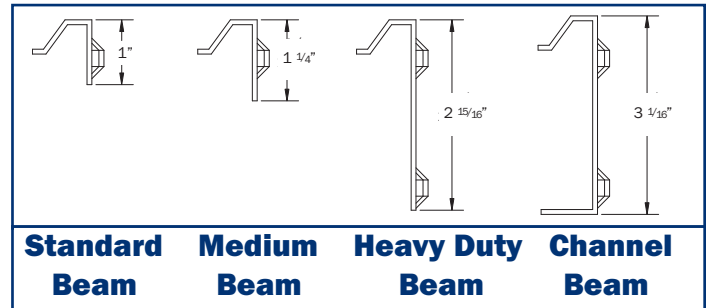

■ Standard Beam

- 14 gauge - 1" tall to support 1/2" or 5/8" particle board or plywood
- one set of double lugs stamped in end that nest in slots in post
- used at intermediate shelf locations front and back of standard units
- widths to 4'

■ Medium Beam

- 14 gauge - 1 1/4" tall to support 3/4" or 7/8" particle board or plywood
- one set of double lugs stamped in end that nest in slots in post
- used at intermediate shelf locations front and back of standard units with thicker deck material
- widths to 4'

■ Heavy Duty Beam

- 14 gauge - 2 15/16" tall
- two sets of double lugs for improved strength and stability
- used top, bottom full perimeter and front-to-back intermediate on standard units
- used full perimeter at all levels on bulk units
- used front-to-back at all levels on high-capacity bulk units
- widths to 8'

■ Channel Beam

- 14 gauge - 3 1/16" tall with 7/8" return flange on bottom of beam
- two sets of double lugs for improved strength and stability
- used side-to-side at all levels on high-capacity bulk units
- widths to 8'

Special Archive Record Units for storing document boxes are also available from the Original Wedge-Lock product line.

Original Wedge-Lock



Standard units provide sturdy, basic storage at an affordable price. A variety of sizes, capacities and shelf levels offer versatile storage in commercial or industrial applications.

The units shown below feature 14 gauge angle and T-posts. Heavy duty beams are used full perimeter at the top and bottom of the unit for stability; standard beams are used side-to-side at intermediate shelf levels. Units are available with framing only, with $\frac{5}{8}$ " particle board deck or with wire deck.

Order one starter unit and the balance as adders to make up a row of shelving. Units are available from stock in color #50 Gray and from production in color #83 Decorator Tan.

Units ship K.D. (knocked down) from Republic's Canton, OH facility.



#50 Gray



#83 Decorator Tan

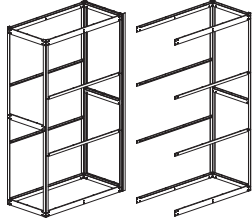
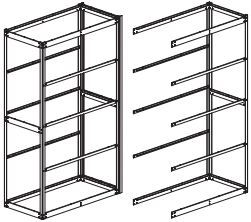
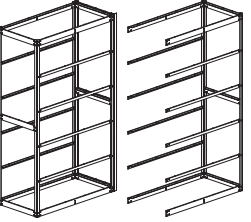
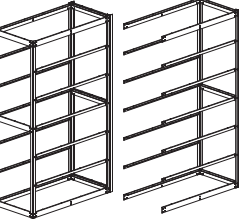

Standard Units										
84" H - no deck			4 Shelves		5 Shelves		6 Shelves		7 Shelves	
W	D	Shelf Cap.	Starter	Adder	Starter	Adder	Starter	Adder	Starter	Adder
36"	12"	425#	DP2100	DP2101	DP2112	DP2113	DP2124	DP2125	DP2136	DP2137
36"	18"	400#	DP2102	DP2103	DP2114	DP2115	DP2126	DP2127	DP2138	DP2139
36"	24"	305#	DP2104	DP2105	DP2116	DP2117	DP2128	DP2129	DP2140	DP2141
48"	12"	310#	DP2106	DP2107	DP2118	DP2119	DP2130	DP2131	DP2142	DP2143
48"	18"	310#	DP2108	DP2109	DP2120	DP2121	DP2132	DP2133	DP2144	DP2145
48"	24"	310#	DP2110	DP2111	DP2122	DP2123	DP2134	DP2135	DP2146	DP2147
84" H - board deck			4 Shelves		5 Shelves		6 Shelves		7 Shelves	
W	D	Capacity	Starter	Adder	Starter	Adder	Starter	Adder	Starter	Adder
36"	12"	425#	DP2100B	DP2101B	DP2112B	DP2113B	DP2124B	DP2125B	DP2136B	DP2137B
36"	18"	400#	DP2102B	DP2103B	DP2114B	DP2115B	DP2126B	DP2127B	DP2138B	DP2139B
36"	24"	305#	DP2104B	DP2105B	DP2116B	DP2117B	DP2128B	DP2129B	DP2140B	DP2141B
48"	12"	310#	DP2106B	DP2107B	DP2118B	DP2119B	DP2130B	DP2131B	DP2142B	DP2143B
48"	18"	310#	DP2108B	DP2109B	DP2120B	DP2121B	DP2132B	DP2133B	DP2144B	DP2145B
48"	24"	310#	DP2110B	DP2111B	DP2122B	DP2123B	DP2134B	DP2135B	DP2146B	DP2147B
84" H - wire deck			4 Shelves		5 Shelves		6 Shelves		7 Shelves	
W	D	Capacity	Starter	Adder	Starter	Adder	Starter	Adder	Starter	Adder
36"	12"	425#	DP2100W	DP2101W	DP2112W	DP2113W	DP2124W	DP2125W	DP2136W	DP2137W
36"	18"	400#	DP2102W	DP2103W	DP2114W	DP2115W	DP2126W	DP2127W	DP2138W	DP2139W
36"	24"	305#	DP2104W	DP2105W	DP2116W	DP2117W	DP2128W	DP2129W	DP2140W	DP2141W
48"	12"	310#	DP2106W	DP2107W	DP2118W	DP2119W	DP2130W	DP2131W	DP2142W	DP2143W
48"	18"	310#	DP2108W	DP2109W	DP2120W	DP2121W	DP2132W	DP2133W	DP2144W	DP2145W
48"	24"	310#	DP2110W	DP2111W	DP2122W	DP2123W	DP2134W	DP2135W	DP2146W	DP2147W

Capacities are based on 1/2" APA C-D Plugged, Group 1, Exp. 1 plywood (with grain running in depth direction) or Type 1-M-1, 5/8" particle board.

Original Wedge-Lock

Original Wedge-Lock **bulk units** have a greater shelf area than standard units, making them ideal for storing large or odd-sized items. The wide range of shelf sizes and capacities, combined with the option of adding extra shelves, allows you to design the bulk shelving system that best meets your needs.

Bulk units feature 14 gauge heavy duty angle and heavy duty T-posts. Heavy duty beams are used full perimeter at all levels on bulk units. Beams are punched to accept front-to-

rear supports supplied with units 36" and 48" deep. Units are available with framing only, with 5/8" particle board deck or with wire deck.

Order one starter unit and the balance as adders to make up a row of shelving. Units are available from stock in color #50 Gray and from production in color #83 Decorator Tan. Units ship K.D. (knocked down) from Republic's Canton, OH facility.



#50 Gray



#83 Decorator Tan

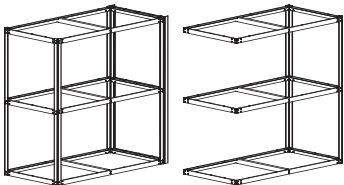
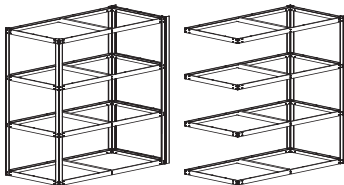

Bulk Units 84"H							Extra shelf includes framing components necessary to add one shelf to an existing unit.
Heavy Beam - no deck			3 Shelves		4 Shelves		
W	D	Shelf Cap.	Starter	Adder	Starter	Adder	Starter
48"	18"	760#	DP2200	DP2201	DP2500	DP2501	DP2280
48"	24"	560#	DP2202	DP2203	DP2502	DP2503	DP2281
48"	36"	760#	DP2204	DP2205	DP2504	DP2505	DP2282
48"	48"	920#	DP2206	DP2207	DP2506	DP2507	DP2283
60"	18"	840#	DP2208	DP2209	DP2508	DP2509	DP2284
60"	24"	700#	DP2210	DP2211	DP2510	DP2511	DP2285
60"	36"	670#	DP2212	DP2213	DP2512	DP2513	DP2286
60"	48"	750#	DP2214	DP2215	DP2514	DP2515	DP2287
72"	18"	1,000#	DP2216	DP2217	DP2516	DP2517	DP2288
72"	24"	770#	DP2218	DP2219	DP2518	DP2519	DP2289
72"	36"	660#	DP2220	DP2221	DP2520	DP2521	DP2290
72"	48"	690#	DP2222	DP2223	DP2522	DP2523	DP2291
96"	18"	900#	DP2224	DP2225	DP2524	DP2525	DP2292
96"	24"	900#	DP2226	DP2227	DP2526	DP2527	DP2293
96"	36"	900#	DP2228	DP2229	DP2528	DP2529	DP2294
96"	48"	900#	DP2230	DP2231	DP2530	DP2531	DP2295
Heavy Beam - board deck			3 Shelves		4 Shelves		Extra Shelf
W	D	Shelf Cap.	Starter	Adder	Starter	Adder	Starter
48"	18"	760#	DP2200B	DP2201B	DP2500B	DP2501B	DP2280B
48"	24"	560#	DP2202B	DP2203B	DP2502B	DP2503B	DP2281B
48"	36"	760#	DP2204B	DP2205B	DP2504B	DP2505B	DP2282B
48"	48"	920#	DP2206B	DP2207B	DP2506B	DP2507B	DP2283B
60"	18"	840#	DP2208B	DP2209B	DP2508B	DP2509B	DP2284B
60"	24"	700#	DP2210B	DP2211B	DP2510B	DP2511B	DP2285B
60"	36"	670#	DP2212B	DP2213B	DP2512B	DP2513B	DP2286B
60"	48"	750#	DP2214B	DP2215B	DP2514B	DP2515B	DP2287B
72"	18"	1,000#	DP2216B	DP2217B	DP2516B	DP2517B	DP2288B
72"	24"	770#	DP2218B	DP2219B	DP2518B	DP2519B	DP2289B
72"	36"	660#	DP2220B	DP2221B	DP2520B	DP2521B	DP2290B
72"	48"	690#	DP2222B	DP2223B	DP2522B	DP2523B	DP2291B
96"	18"	900#	DP2224B	DP2225B	DP2524B	DP2525B	DP2292B
96"	24"	900#	DP2226B	DP2227B	DP2526B	DP2527B	DP2293B
96"	36"	900#	DP2228B	DP2229B	DP2528B	DP2529B	DP2294B
96"	48"	900#	DP2230B	DP2231B	DP2530B	DP2531B	DP2295B

Capacities are based on evenly distributed loads on one shelf when 5/8" Type 1-M-1 particle board is used as decking.

Original Wedge-Lock

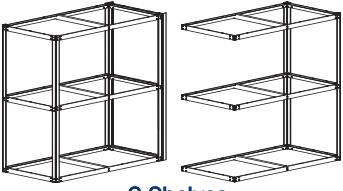
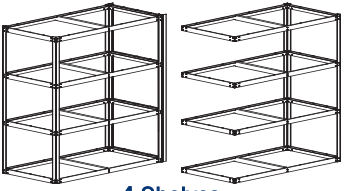
Bulk Units 84"H							Extra shelf includes framing components necessary to add one shelf to an existing unit.
Heavy Beam - wire deck			3 Shelves		4 Shelves		
W	D	Shelf Cap.	Starter	Adder	Starter	Adder	Starter
48"	18"	760#	DP2200W	DP2201W	DP2500W	DP2501W	DP2280W
48"	24"	560#	DP2202W	DP2203W	DP2502W	DP2503W	DP2281W
48"	36"	760#	DP2204W	DP2205W	DP2504W	DP2505W	DP2282W
48"	48"	920#	DP2206W	DP2207W	DP2506W	DP2507W	DP2283W
60"	18"	840#	DP2208W	DP2209W	DP2508W	DP2509W	DP2284W
60"	24"	700#	DP2210W	DP2211W	DP2510W	DP2511W	DP2285W
60"	36"	670#	DP2212W	DP2213W	DP2512W	DP2513W	DP2286W
60"	48"	750#	DP2214W	DP2215W	DP2514W	DP2515W	DP2287W
72"	18"	1,000#	DP2216W	DP2217W	DP2516W	DP2517W	DP2288W
72"	24"	770#	DP2218W	DP2219W	DP2518W	DP2519W	DP2289W
72"	36"	660#	DP2220W	DP2221W	DP2520W	DP2521W	DP2290W
72"	48"	690#	DP2222W	DP2223W	DP2522W	DP2523W	DP2291W
96"	18"	900#	DP2224W	DP2225W	DP2524W	DP2525W	DP2292W
96"	24"	900#	DP2226W	DP2227W	DP2526W	DP2527W	DP2293W
96"	36"	900#	DP2228W	DP2229W	DP2528W	DP2529W	DP2294W
96"	48"	900#	DP2230W	DP2231W	DP2530W	DP2531W	DP2295W

When extra capacity is needed, upgrade to **high-capacity bulk units**. Shelves can carry up to double the load of regular bulk units. Extra shelves can be added for additional storage area and capacity.

High-capacity bulk units feature 14 ga. heavy duty angle and heavy duty T-posts.

Channel beams are used side-to-side on high-capacity bulk units. Beams are punched to accept front-to-rear supports supplied with units 36" and 48" deep. Units are available with framing only, with 5/8" particle board deck or with wire deck.

Order one starter unit and the balance as adders to make up a row of shelving.

Units are available from stock in #50 Gray and from production in #83 Decorator Tan. Units ship K.D. (knocked down) from Republic's Canton, OH facility.

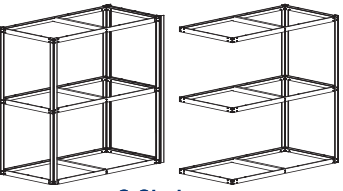
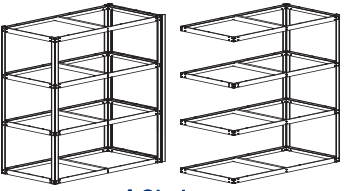

High Capacity Bulk Units 84"H							Extra shelf includes framing components necessary to add one shelf to an existing unit.
Channel Beam - no deck			3 Shelves		4 Shelves		
W	D	Shelf Cap.	Starter	Adder	Starter	Adder	Starter
48"	18"	770#	DP2200H	DP2201H	DP2500H	DP2501H	DP2280H
48"	24"	700#	DP2202H	DP2203H	DP2502H	DP2503H	DP2281H
48"	36"	760#	DP2204H	DP2205H	DP2504H	DP2505H	DP2282H
48"	48"	920#	DP2206H	DP2207H	DP2506H	DP2507H	DP2283H
60"	18"	1,140#	DP2208H	DP2209H	DP2508H	DP2509H	DP2284H
60"	24"	1,180#	DP2210H	DP2211H	DP2510H	DP2511H	DP2285H
60"	36"	1,520#	DP2212H	DP2213H	DP2512H	DP2513H	DP2286H
60"	48"	1,680#	DP2214H	DP2215H	DP2514H	DP2515H	DP2287H
72"	18"	1,200#	DP2216H	DP2217H	DP2516H	DP2517H	DP2288H
72"	24"	1,140#	DP2218H	DP2219H	DP2518H	DP2519H	DP2289H
72"	36"	1,330#	DP2220H	DP2221H	DP2520H	DP2521H	DP2290H
72"	48"	1,670#	DP2822H	DP2223H	DP2522H	DP2523H	DP2291H
96"	18"	1,500#	DP2224H	DP2225H	DP2524H	DP2525H	DP2292H
96"	24"	1,200#	DP2226H	DP2227H	DP2526H	DP2527H	DP2293H
96"	36"	1,150#	DP2228H	DP2229H	DP2528H	DP2529H	DP2294H
96"	48"	1,330#	DP2230H	DP2231H	DP2530H	DP2531H	DP2295H

Capacities are based on evenly distributed loads on one shelf when 5/8" Type 1-M-1 particle board is used as decking.

Original Wedge-Lock

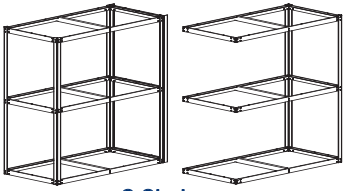
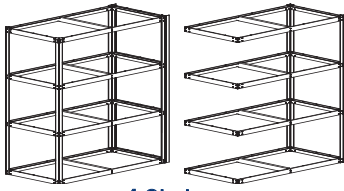
High Capacity Bulk Units 84" H			 3 Shelves		 4 Shelves		Extra shelf includes framing components necessary to add one shelf to an existing unit.
Channel Beam - board deck			3 Shelves		4 Shelves		Extra Shelf
W	D	Shelf Cap.	Starter	Adder	Starter	Adder	Starter
48"	18"	770#	D2200HB	D2201HB	D2500HB	D2501HB	D2280HB
48"	24"	700#	D2202HB	D2203HB	D2502HB	D2503HB	D2281HB
48"	36"	760#	D2204HB	D2205HB	D2504HB	D2505HB	D2282HB
48"	48"	920#	D2206HB	D2207HB	D2506HB	D2507HB	D2283HB
60"	18"	1,140#	D2208HB	D2209HB	D2508HB	D2509HB	D2284HB
60"	24"	1,180#	D2210HB	D2211HB	D2510HB	D2511HB	D2285HB
60"	36"	1,520#	D2212HB	D2213HB	D2512HB	D2513HB	D2286HB
60"	48"	1,680#	D2214HB	D2215HB	D2514HB	D2515HB	D2287HB
72"	18"	1,200#	D2216HB	D2217HB	D2516HB	D2517HB	D2288HB
72"	24"	1,140#	D2218HB	D2219HB	D2518HB	D2519HB	D2289HB
72"	36"	1,330#	D2220HB	D2221HB	D2520HB	D2521HB	D2290HB
72"	48"	1,670#	D2222HB	D2223HB	D2522HB	D2523HB	D2291HB
96"	18"	1,500#	D2224HB	D2225HB	D2524HB	D2525HB	D2292HB
96"	24"	1,200#	D2226HB	D2227HB	D2526HB	D2527HB	D2293HB
96"	36"	1,150#	D2228HB	D2229HB	D2528HB	D2529HB	D2294HB
96"	48"	1,330#	D2230HB	D2231HB	D2530HB	D2531HB	D2295HB
Channel Beam - wire deck			3 Shelves		4 Shelves		Extra Shelf
W	D	Shelf Cap.	Starter	Adder	Starter	Adder	Starter
48"	18"	770#	D2200HW	D2201HW	D2500HW	D2501HW	D2280HW
48"	24"	700#	D2202HW	D2203HW	D2502HW	D2503HW	D2281HW
48"	36"	760#	D2204HW	D2205HW	D2504HW	D2505HW	D2282HW
48"	48"	920#	D2206HW	D2207HW	D2506HW	D2507HW	D2283HW
60"	18"	1,140#	D2208HW	D2209HW	D2508HW	D2509HW	D2284HW
60"	24"	1,180#	D2210HW	D2211HW	D2510HW	D2511HW	D2285HW
60"	36"	1,520#	D2212HW	D2213HW	D2512HW	D2513HW	D2286HW
60"	48"	1,680#	D2214HW	D2215HW	D2514HW	D2515HW	D2287HW
72"	18"	1,200#	D2216HW	D2217HW	D2516HW	D2517HW	D2288HW
72"	24"	1,140#	D2218HW	D2219HW	D2518HW	D2519HW	D2289HW
72"	36"	1,330#	D2220HW	D2221HW	D2520HW	D2521HW	D2290HW
72"	48"	1,670#	D2222HW	D2223HW	D2522HW	D2523HW	D2291HW
96"	18"	1,500#	D2224HW	D2225HW	D2524HW	D2525HW	D2292HW
96"	24"	1,200#	D2226HW	D2227HW	D2526HW	D2527HW	D2293HW
96"	36"	1,150#	D2228HW	D2229HW	D2528HW	D2529HW	D2294HW
96"	48"	1,330#	D2230HW	D2231HW	D2530HW	D2531HW	D2295HW

Capacities are based on evenly distributed loads on one shelf when 5/8" Type 1-M-1 particle board is used as decking.

Components

Stock components shown in bold.

Standard Angle Post

6'0" high	220021
7'0" high	220027
8'0" high	220033
10'0" high	220045

Heavy Angle Post

6'0" high	220313
7'0" high	220319
8'0" high	220325
10'0" high	220337
12'0" high	220349
14'0" high	220361
16'0" high	220405
Splice Kit	292004

Standard T Post

6'0" high	220079
7'0" high	220085
8'0" high	220091
10'0" high	220103

Heavy T Post

6'0" high	220137
7'0" high	220143
8'0" high	220149
10'0" high	220161
12'0" high	220173
14'0" high	220185
16'0" high	220402
Splice Kit	292006

Foot Plate

2 ²⁹ / ₃₂ " x 1 ²³ / ₃₂ "	292001
---	---------------

Standard Duty Beam

12" wide/deep	220193
18" wide/deep	220195
24" wide/deep	220197
30" wide/deep	220199
36" wide/deep	220201
48" wide/deep	220205

Medium Duty Beam

24" wide/deep	220210
36" wide/deep	220214
48" wide/deep	220218

Heavy Duty Beam

12" wide/deep	220220
15" wide/deep	220221
18" wide/deep	220222
24" wide/deep	220224
30" wide/deep	220226
36" wide/deep	220228
42" wide/deep	220230
48" wide/deep	220232
60" wide/deep	220234
69" wide/deep	220236
72" wide/deep	220237
96" wide/deep	220239

Channel Beam

48" wide/deep	220240
60" wide/deep	220241
69" wide/deep	220371
72" wide/deep	220242
96" wide/deep	220244

Channel Support

18" deep	230267
24" deep	230269
30" deep	230271
36" deep	230273
48" deep	230277

Standard Duty Support

12" deep	220245
18" deep	220247
24" deep	220249

Heavy Duty Support

30" deep	220252
36" deep	220254
48" deep	220258

5/8" Particle Board Shelf

36" wide x 12" deep	702076
36" wide x 18" deep	702077
36" wide x 24" deep	702078
48" wide x 12" deep	702079
48" wide x 18" deep	702080
48" wide x 24" deep	702081
48" wide x 36" deep	702083
48" wide x 48" deep	702084
60" wide x 18" deep	702085
60" wide x 24" deep	702086
60" wide x 36" deep	702088
60" wide x 48" deep	702089
72" wide x 18" deep	702090
72" wide x 24" deep	702091
72" wide x 36" deep	702093
72" wide x 48" deep	702094
96" wide x 18" deep	702095
96" wide x 24" deep	702096
96" wide x 36" deep	702097
96" wide x 48" deep	702098

Wire Deck Shelf

36" wide x 12" deep	702151
36" wide x 18" deep	702152
36" wide x 24" deep	702153
48" wide x 12" deep	702154
48" wide x 18" deep	702155
48" wide x 24" deep	702156
48" wide x 36" deep	702157
48" wide x 48" deep	702158
60" wide x 18" deep	702159
60" wide x 24" deep	702160
60" wide x 36" deep	702161
60" wide x 48" deep	702162
72" wide x 18" deep	702163
72" wide x 24" deep	702164
72" wide x 36" deep	702165
72" wide x 48" deep	702166
96" wide x 18" deep	702167
96" wide x 24" deep	702168
96" wide x 36" deep	702169
96" wide x 48" deep	702170

